

MOUNTING REFERENCE GUIDE

Accessories

CIM Cable Integrated Mounting System



THINK BEFORE
YOU PRINT



Content

General notes	3
How to create part numbers	4
Drawer	5
Infusion Pump Mount	7
Fixings for Drawers and Infusion Pump Mounts	12
Basket	13
Fixings for Baskets	14
Table Column / Floor Column	15
Cable Management	17
Fixings for Cable Hooks	19
Q-Fit	20
CPU Clamp and Universal Clamp	21
Fixings for CPU Clamps and Universal Clamps	22
Power Supply Holster	23
Fixings for Power Supply Holster	24
Wall Channel and European Rail	25
Keyboard Tray	26
Fixings for Keyboard Trays	27
Handle	28
Down Post	30
Miscellaneous	31
Fixings for Holder Barcode Scanner	32

General notes

Custom-designed solutions and MRI applications

Please contact us for **custom-designed** solutions.

Product marking

All products which are classified as medical product risk class 1 are CE marked. As **medical product risk class 1** they are conform with the regulations (EU) 2017/745 (MDR) and IEC 60601-1. Other standards of the IEC 60601 series are not applicable to our products, regardless of their version.

MD A stand-alone product that is already classified as a medical product class 1 before being integrated into an overall medical device. The product is CE-marked. A declaration of conformity is available.

~~MD~~ Accessories or spare parts that have no independent function and are therefore not subject to the MDR. These products are not CE-marked. A declaration of conformity is not required.

Warranty

All CIM products have a 5-year warranty to be free of defects in material and functionality from the date of delivery.

How to find the right product for your needs?

No problem with our configurator

<https://cim-configurator.com>



How to create part numbers

Part numbers can be easily created by following the steps below:

Please replace the letters in **green** with the part no. code as per your requirements.

1. Specify where you want to mount the arm and select the fixing (Y):

1V	=	pole ø 23 - 40 mm / 0.9 - 1.6"
1	=	pole ø 25 mm / 1.0"
1B	=	pole ø 30 mm / 1.2"
1F	=	pole ø 35 mm / 1.4"
1C	=	pole ø 38 mm / 1.5"
2F	=	horizontal rails 10 x 25, 8 x 35, 10 x 30, 10 x 50 mm
3	=	vertical rail 10 x 25 mm
4S	=	vertical wall channel
4V	=	vertical wall channel (only for drawers)
4Z	=	vertical wall channel (only for accessories, not for support arms)
5	=	horizontal rails 10 x 25, 8 x 35, 10 x 30 mm
6H / 6R	=	horizontal rails 10 x 25, 8 x 35, 10 x 30, 10 x 50 mm
6V	=	vertical rails 10 x 25, 8 x 35, 10 x 30, 10 x 50 mm
19	=	Dräger Ambia pendants & headwalls
70	=	non-height adjustable arms
71	=	height adjustable arms

2. Choose the colour requested for decorative parts (C):

gr	=	RAL 7024 (graphite grey)
bl	=	RAL 5013 (cobalt blue)
w	=	RAL 9016 (traffic white) only for drawers, wall channels and handle for carts

3. Choose the colour requested for the aluminium die-cast parts (D):

1	=	RAL 9016 (traffic white)
2	=	RAL 9002 (grey white)

Example

Area of application		Typ of accessory		01 Fixing		02 & 03 Colour		04 Keyboard Tray
Z	-	EF	-	Y	.	CD	-	T
Z	-	EF	-	4S	.	bl1	-	50S

Drawer

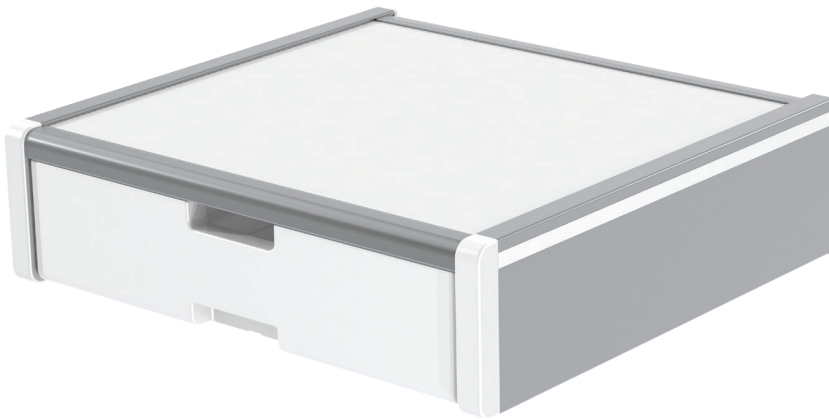

Dimensions	440 x 413 x 120 mm / 17.3 x 16.3 x 4.7" (W x D x H)
Drawer dimensions	375 x 335 x 85 mm / 14.8 x 13.2 x 3.3" (W x D x H)
Material	Aluminium, HPL (high pressure laminate), ABS
Surface	Anodized, HPL and ABS (= scratch-proof, resistant against impact and disinfectants)
Colour	RAL 9016 traffic white
Max. load capacity	25 kg / 55.1 lbs (4-fold safety)
Drawer max. weight	5 kg / 11 lbs
Product weight	7.1 kg / 15.6 lbs 7.4 kg / 16.3 lbs (with laterally rails)
Part number	Z-SLK-Y.w Z-SLK-NS-Y.w with (2) laterally rails 25 x 10 x 350 mm

Fixings Y

details page 12

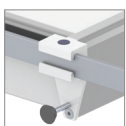

2F

Horizontal rail clamp

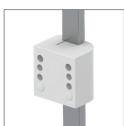

3

Vertical rail clamp



4V

Adapter for vertical wall channel



1V

Universal pole clamp

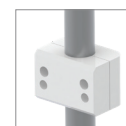

1

IB

1F

1C

Fixed pole clamp

Drawer

Technical data

SIDE VIEW

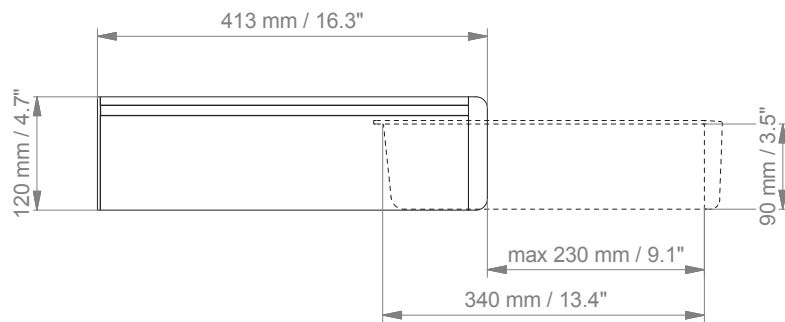

TOP VIEW

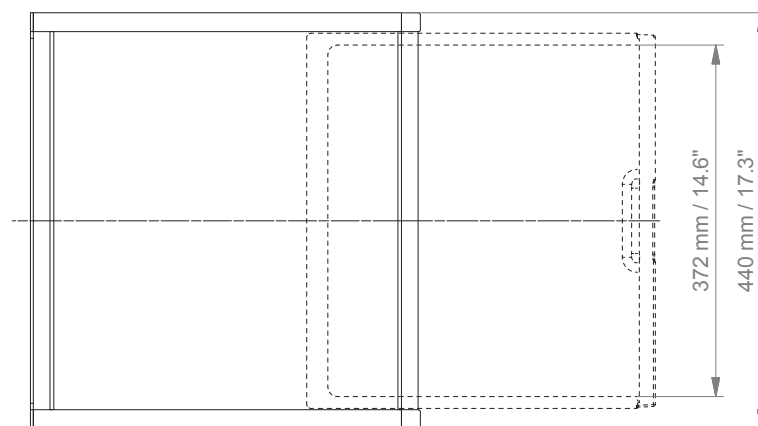

Infusion pump mount - pivot arm

MD



Colours to choose D

Aluminium parts: RAL 9016 traffic white (1) / RAL 9002 grey white (2)

Maximum weight

16.5 kg / 36.4 lbs; 23 kg / 50.1 lbs; 30 kg / 66.1 lbs (6-fold safety)

Front pole clamp

ø 25 mm / 1"

Part number

Part number	Part number	Armtime	Arm length	Maximum weight	Product weight
Z-224RR-Y.D	240	240	261 mm / 10.3"	30 kg / 66.1 lbs	1.2 kg / 2.6 lbs
Z-230RR-Y.D	300	300	321 mm / 12.6"	23 kg / 50.7 lbs	1.3 kg / 2.9 lbs
Z-240RR-Y.D	400	400	421 mm / 16.5"	16.5 kg / 36.4 lbs	1.5 kg / 3.3 lbs

Fixings Y

details page 12



2F

Horizontal rail clamp

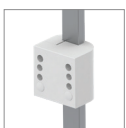

3

Vertical rail clamp



4S

Adapter for vertical wall channel



1V

Universal pole clamp



1

1B

1F

1C

Fixed pole clamp



19

Adapter for Dräger Ambia pendants & headwalls

Infusion pump mount - pivot arm

Technical data - arm type 240

SIDE VIEW

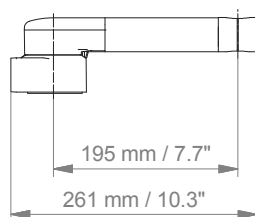

TOP VIEW

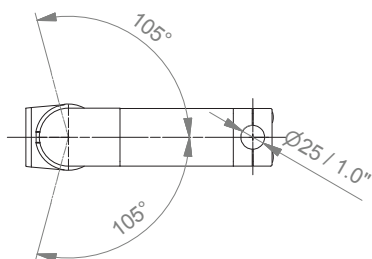

Infusion pump mount - extended pivot arm heavy duty

MD



Colours to choose D

Aluminium parts: RAL 9016 pure white (1) / RAL 9002 grey white (2)

Maximum weight

23 kg / 50.7 lbs (6-fold safety)

Product weight

2.5 kg / 5.5 lbs

Front pole clamp

ø 25 mm / 1"

Part number

Z-H33030RR-Y.D

The combination of two or more extended pivot arms with an IV pole is not permitted.

Fixings Y

details page 12



2F

Horizontal rail clamp

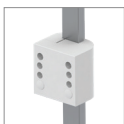

3

Vertical rail clamp



4S

Adapter for vertical wall channel



1V

Universal pole clamp

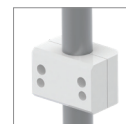

1

1B

1F

1C

Fixed pole clamp



19

Adapter for Dräger Ambia pendants & headwalls

Infusion pump mount - extended pivot arm heavy duty

Technical data

SIDE VIEW

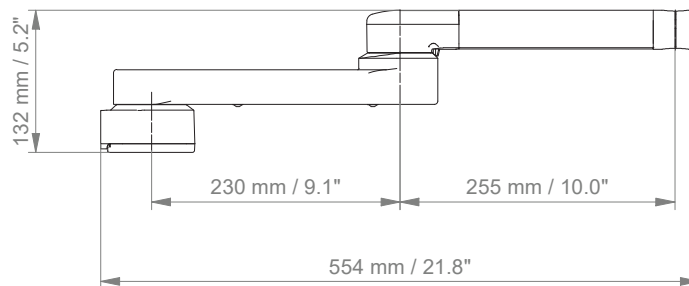

TOP VIEW

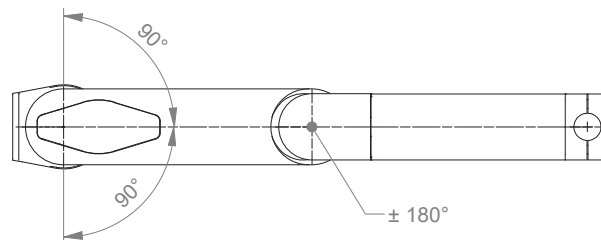

Infusion pump mount - accessories

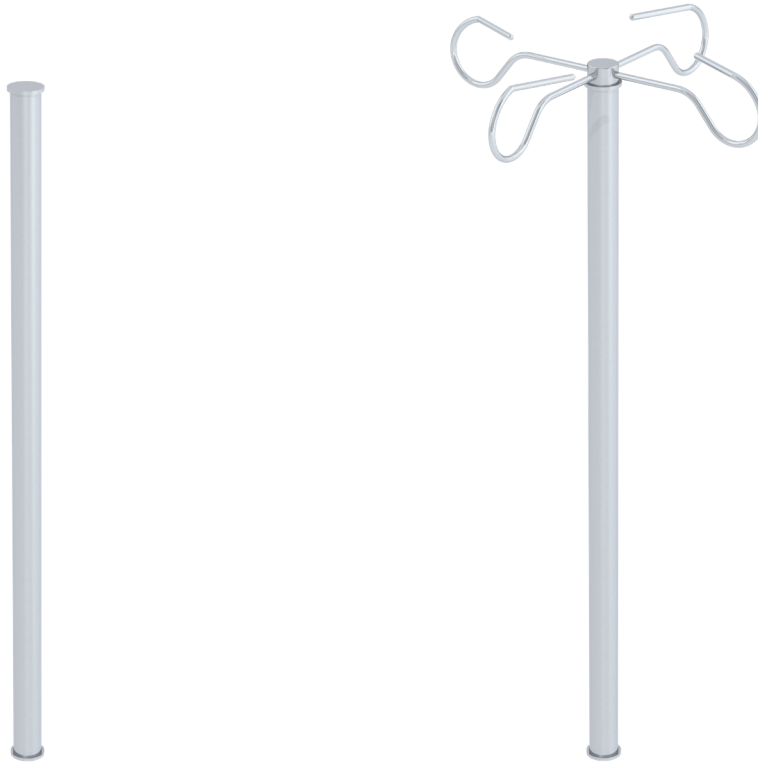

Material

Stainless steel

Part number

Infusion pole ø 25 mm / 1"

Part number	Length	Product weight
Z-IF_600	600 mm / 23.6"	0.7 kg / 1.5 lbs
Z-IF_1200	1200 mm / 47.2"	1.3 kg / 2.9 lbs

Infusion pole ø 25 mm / 1" with infusion bag hooks

Part number	Length	Product weight
Z-IF6_600	600 mm / 23.6"	0.9 kg / 2.0 lbs
Z-IF6_1200	1200 mm / 47.2"	1.5 kg / 3.3 lbs

Fixings Y

for drawers and infusion pump mount

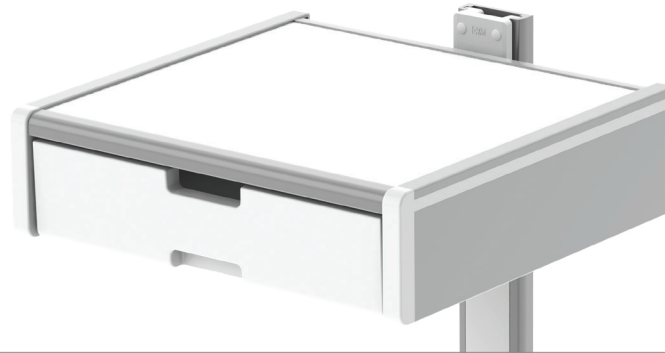









Illustration	Description	Notes	Weight	Part no.
	Horizontal rail clamp	To mount to horizontal European rails 10 x 25, 8 x 35, 10 x 30, 10 x 50 mm	1.1 kg / 2.4 lbs	2F
	Vertical rail clamp	To mount to vertical European rail 10 x 25 mm	0.5 kg / 1.1 lbs	3
	Adapter for vertical wall channel	To mount to CIM wall channel (compatible with GCX channel) only for drawers	0.4 kg / 0.9 lbs	4V
	Adapter for vertical wall channel	To mount to CIM wall channel (compatible with GCX channel)	0.6 kg / 1.3 lbs	4S
	Universal pole clamp	V-block to mount to pole \varnothing 23 - 40 mm / 0.9 - 1.6"	0.6 kg / 1.3 lbs	1V
	Fixed pole clamp	To mount to pole \varnothing 25 mm / 1.0" To mount to pole \varnothing 30 mm / 1.2" To mount to pole \varnothing 35 mm / 1.4" To mount to pole \varnothing 38 mm / 1.5"	0.3 kg / 0.7 lbs 0.4 kg / 0.9 lbs 0.4 kg / 0.9 lbs 0.4 kg / 0.9 lbs	1 1B 1F 1C
	Adapter pendants & headwalls	For Dräger Ambia pendants & headwalls	0.6 kg / 1.3 lbs	19

Basket



Dimensions (W x D x H)

Basket big

300 x 200 x 180 mm / 11.8 x 7.9 x 7.1"

Basket small

200 x 150 x 100 mm / 7.9 x 5.9 x 3.9"

Maximum load
Product weight

10 kg / 22 lbs
1.1 kg / 2.4 lbs

2.5 kg / 5.5 lbs
0.6 kg / 1.3 lbs

Part number

Z-51-Y.1

Z-52-Y.1

Fixings Y

details page 14

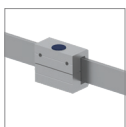

6H
6R

Horizontal rail clamp

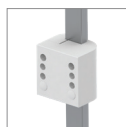

3

Vertical rail clamp



4Z

Adapter for vertical wall channel



1V

Universal pole clamp

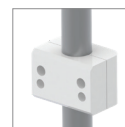

1
1B
1F
1C

Fixed pole clamp



70

Bracket with swivel function



71

Bracket with swivel function

Fixings Y for baskets









Illustration	Description	Notes	Weight	Part no.
	Horizontal rail clamp	To mount to horizontal rail 10 x 25, 8 x 35, 10 x 30, 10 x 50 mm With locking, to mount to horizontal rail 10 x 25, 8 x 35, 10 x 30, 10 x 50 mm	0.2 kg / 0.4 lbs 0.2 kg / 0.4 lbs	6H 6R
	Vertical rail clamp	To mount to vertical European rail 10 x 25 mm	0.5 kg / 1.1 lbs	3
	Adapter for vertical wall channel	To mount to CIM wall channel (compatible with GCX channel)	0.2 kg / 0.4 lbs	4Z
	Universal pole clamp	V-block to mount to pole ø 23 - 40 mm / 0.9 - 1.6"	0.6 kg / 1.3 lbs	1V
	Fixed pole clamp	To mount to pole ø 25 mm / 1.0" To mount to pole ø 30 mm / 1.2" To mount to pole ø 35 mm / 1.4" To mount to pole ø 38 mm / 1.5"	0.3 kg / 0.7 lbs 0.4 kg / 0.9 lbs 0.4 kg / 0.9 lbs 0.4 kg / 0.9 lbs	1 1B 1F 1C
	Bracket for basket with swivel function	To mount to non-height adjustable arms	0.3 kg / 0.7 lbs	70
	Bracket for basket with swivel function	To mount to height adjustable arms	0.3 kg / 0.7 lbs	71

Table column / floor column

MD



The column profile can be mounted to table or floor. The opposite C-profiles are intended to accept all CIM arms and/ or CIM components.

Besides the standard length of the column indicated below, individually required lengths are available on request.

Table column	L 800 mm / 31.5"
Floor plate	150 x 150 mm / 5.9 x 5.9", hole pattern 126 x 126 mm / 5 x 5"
Product weight	2.9 kg / 6.4 lbs
Part number	T-CTP-60.w1_800

Table column / floor column

Technical data

TOP VIEW

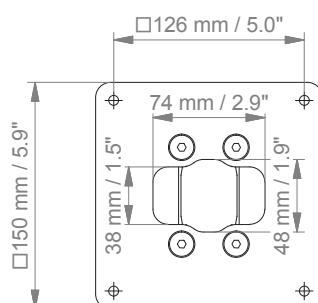

SIDE VIEW

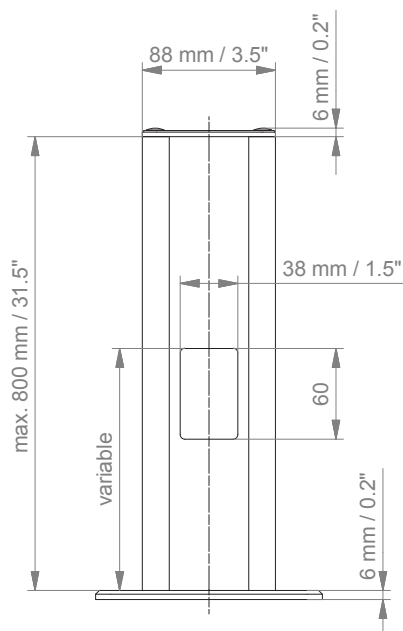



Cable Management - Cable hook



Illustration	Description	Fixing	Weight	Part no.
	Dual cable hook To mount to front joint of arm	To mount to non-height adjustable arms	0.4 kg / 0.9 lbs	Z-KH2-70.1
		To mount to height adjustable arms	0.4 kg / 0.9 lbs	Z-KH2-71.1
	Dual cable hook	Details page 19	0.4 kg / 0.9 lbs	Z-KH2-Y.1
	Triple cable hook To mount to front joint of arm	To mount to non-height adjustable arms	0.5 kg / 1.1 lbs	Z-KH3-70.1
		To mount to height adjustable arms	0.5 kg / 1.1 lbs	Z-KH3-71.1
	Triple cable hook	Details page 19	0.6 kg / 1.3 lbs	Z-KH3-Y.1

Cable Management - Cable hook







Illustration	Description	Fixing	Weight	Part no.
	Dual cable hook with down post rotatable To mount to front joint of arm	To mount to non-height adjustable arms Length 150 mm / 5.9"	0.4 kg / 0.9 lbs	Z-KH2-70.1_150
		To mount to height adjustable arms Length 150 mm / 5.9"	0.4 kg / 0.9 lbs	Z-KH2-71.1_150
	Triple cable hook with down post rotatable To mount to front joint of arm	To mount to non-height adjustable arms Length 150 mm / 5.9"	0.6 kg / 1.3 lbs	Z-KH3-70.1_150
		To mount to height adjustable arms Length 150 mm / 5.9"	0.6 kg / 1.3 lbs	Z-KH3-71.1_150
	Down post with cable hook To mount to front joint of arm	To mount to non-height adjustable arms Length 150 mm / 5.9" Length 300 mm / 11.8"	0.3 kg / 0.7 lbs 0.4 kg / 0.9 lbs	Z-KH6-70.1_150 Z-KH6-70.1_300
		To mount to height adjustable arms Length 150 mm / 5.9" Length 300 mm / 11.8"	0.3 kg / 0.7 lbs 0.4 kg / 0.9 lbs	Z-KH6-71.1_150 Z-KH6-71.1_300

Fixings Y

for cable hooks



Illustration	Description	Notes	Weight	Part no.
	Horizontal rail clamp	To mount to horizontal rail 10 x 25, 8 x 35, 10 x 30, 10 x 50 mm With locking, to mount to horizontal rail 10 x 25, 8 x 35, 10 x 30, 10 x 50 mm	0.2 kg / 0.4 lbs 0.2 kg / 0.4 lbs	6H 6R
	Vertical rail clamp	To mount to vertical European rail 10 x 25 mm	0.5 kg / 1.1 lbs	3
	Adapter for vertical wall channel	To mount to CIM wall channel (compatible with GCX channel)	0.1 kg / 0.2 lbs	4Z
	Universal pole clamp	V-block to mount to poles ø 23 - 40 mm / ø 0.9 - 1.6"	0.6 kg / 1.3 lbs	1V
	Fixed pole clamp	To mount to pole ø 25 mm / ø 1" To mount to pole ø 30 mm / ø 1.2" To mount to pole ø 35 mm / ø 1.4" To mount to pole ø 38 mm / ø 1.5"	0.3 kg / 0.7 lbs 0.4 kg / 0.9 lbs 0.4 kg / 0.9 lbs 0.4 kg / 0.9 lbs	1 1B 1F 1C

Cable management

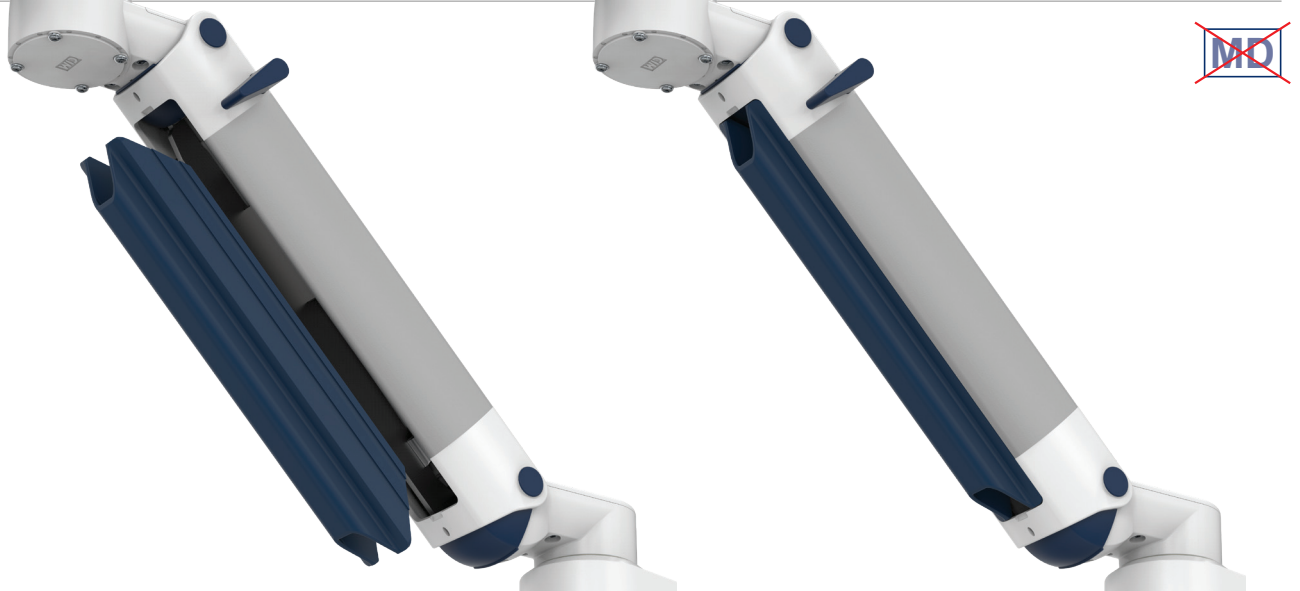
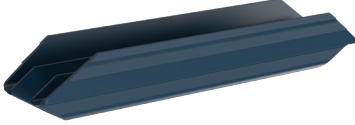





Illustration	Description	Notes	Weight	Part no.
	Q-Fit	Cover profile for height adjustable arms Cover profile for height adjustable arms, part is ordered together with the support arm. Colours to choose: (C): RAL 7024 graphite grey (gr) or RAL 5013 cobalt blue (bl)	0.1 kg / 0.2 lbs 0.1 kg / 0.2 lbs	Z-QFIT.C O-QFIT.C
	Q-Fit	Cover profile for extension Cover profile for extension, part is ordered together with the support arm.	0.1 kg / 0.2 lbs 0.1 kg / 0.2 lbs	Z-QFIT.EXT O-QFIT.EXT
	Cable clip	For down post \varnothing 25 mm, L 100 mm / \varnothing 1", L 3.9" Colours to choose: (C): RAL 7024 graphite grey (gr) or RAL 5013 cobalt blue (bl)	0.1 kg / 0.2 lbs	Z-KC-1.C

CPU clamp and universal clamp



Illustration	Description	Notes	Weight	Part no.
	<p>CPU dual clamp set</p> <p>Existing of: 2 clamps (top and bottom) 2 fixings for vertical wall channel</p> <p>Colour to choose (D): RAL 9016 traffic white (1) or RAL 9002 grey white (2)</p>	<p>CPU width</p> <p>27 - 45 mm / 1.1 - 1.8" 45 - 70 mm / 1.8 - 2.8" 60 - 100 mm / 2.4 - 3.9" 85 - 150 mm / 3.3 - 5.9"</p> <p>With extension plate</p> <p>130 - 170 mm / 5.1 - 6.7" 170 - 215 mm / 6.7 - 8.5"</p>	<p>0.3 kg / 0.7 lbs 0.4 kg / 0.9 lbs 0.4 kg / 0.9 lbs 0.5 kg / 1.1 lbs 0.6 kg / 1.3 lbs 0.7 kg / 1.5 lbs</p>	<p>Z-CPU-4.D_27 Z-CPU-4.D_45 Z-CPU-4.D_60 Z-CPU-4.D_85 Z-CPU-4.D_130 Z-CPU-4.D_170</p>
	<p>Universal clamp</p> <p>Adjustable from 35 - 57 mm / 1.4 - 2.3" 48 - 63 mm / 1.9 - 2.5"</p> <p>Colour to choose (D): RAL 9016 traffic white (1) or RAL 9002 grey white (2)</p>	<p>Details page 22</p>	<p>0.2 kg / 0.4 lbs 0.2 kg / 0.4 lbs</p>	<p>Z-UK-Y.D_35 Z-UK-Y.D_48</p>

Fixings Y

for universal clamps

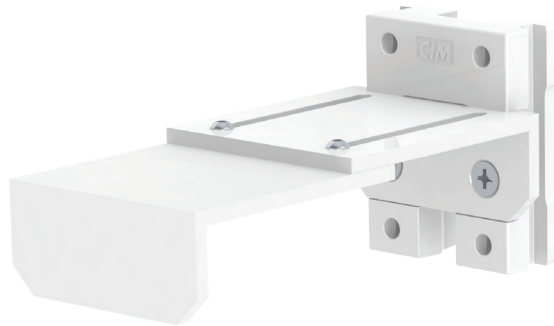





Illustration	Description	Notes	Weight	Part no.
	Universal pole clamp	V-block to mount to poles \varnothing 23 - 40 mm / \varnothing 0.9 - 1.6"	0.6 kg / 1.3 lbs	1V
	Horizontal rail clamp	To mount to horizontal rail 10 x 25, 8 x 35, 10 x 30, 10 x 50 mm With locking, to mount to horizontal rail 10 x 25, 8 x 35, 10 x 30, 10 x 50 mm	0.2 kg / 0.4 lbs 0.2 kg / 0.4 lbs	6H 6R
	Adapter for wall channel	To mount to vertical CIM wall channel (compatible with GCX channel)	0.1 kg / 0.2 lbs	4Z

Power supply holster







Illustration	Description	Notes	Weight	Part no.
	<p>Power supply enclosure</p> <p>Double 255 x 115 x 85 mm Double 10 x 4.5 x 3.4"</p> <p>Triple 255 x 165 x 85 mm Triple 10 x 6.5 x 3.4" (Dimensions H x W x D)</p>	<p>Details page 24</p>	<p>1.0 kg / 2.2 lbs</p> <p>1.3 kg / 2.9 lbs</p>	<p>Z-PS2-Y.1</p> <p>Z-PS3-Y.1</p>
	<p>Power supply holster</p> <p>143 x 126 x 48 mm 5.6 x 5 x 1.9" (Dimensions H x W x D)</p> <p>Universal power supply holster for different sizes</p>	<p>Details page 24</p>	<p>0.6 kg / 1.3 lbs</p>	<p>Z-NH-Y.1</p>

Fixings Y

for power supply holster



Illustration	Description	Notes	Weight	Part no.
	Horizontal rail clamp	To mount to horizontal rail 10 x 25, 8 x 35, 10 x 30, 10 x 50 mm	0.2 kg / 0.4 lbs	6H
	Vertical rail clamp	To mount to vertical rail 10 x 25, 8 x 35, 10 x 30, 10 x 50 mm	0.2 kg / 0.4 lbs	6V
	Adapter for vertical wall channel	To mount to vertical CIM wall channel (compatible with GCX channel)	0.1 kg / 0.2 lbs	4Z
	Universal pole clamp	V-block to mount to poles ø 23 - 40 mm / ø 0.9 - 1.6"	0.6 kg / 1.3 lbs	1V
	Fixed pole clamp	To mount to pole ø 25 mm / ø 1" To mount to pole ø 30 mm / ø 1.2" To mount to pole ø 35 mm / ø 1.4" To mount to pole ø 38 mm / ø 1.5"	0.3 kg / 0.7 lbs 0.4 kg / 0.9 lbs 0.4 kg / 0.9 lbs 0.4 kg / 0.9 lbs	1 1B 1F 1C

Wall channel and European rail

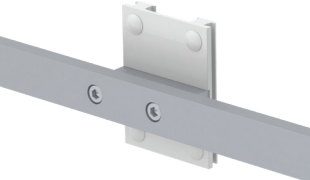

Illustration	Description	Length	Weight	Part no.
	<p>CIM wall channel</p> <p>Vertical wall channel including channel cover and end caps</p> <p>Individual lengths on request!</p> <p>Channel cover available in two colours (C): RAL 7024 graphite grey (gr) or RAL 9016 traffic white (w)</p>	<p>480 mm / 18.9"</p> <p>720 mm / 28.3"</p> <p>960 mm / 37.8"</p> <p>1200 mm / 47.2"</p>	<p>0.9 kg / 2.0 lbs</p> <p>1.3 kg / 2.9 lbs</p> <p>1.7 kg / 3.7 lbs</p> <p>2.1 kg / 4.6 lbs</p>	<p>Z-WK.C_480</p> <p>Z-WK.C_720</p> <p>Z-WK.C_960</p> <p>Z-WK.C_1200</p>
	<p>European rail 10 x 25 mm</p> <p>To mount to CIM wall channel including adapter for vertical wall channel</p>	<p>300 mm / 11.8"</p> <p>400 mm / 15.7"</p> <p>500 mm / 19.7"</p>	<p>0.4 kg / 0.9 lbs</p> <p>0.5 kg / 1.1 lbs</p> <p>0.5 kg / 1.1 lbs</p>	<p>Z-NS-4Z.1_300</p> <p>Z-NS-4Z.1_400</p> <p>Z-NS-4Z.1_500</p>

Keyboard tray



Illustration	Description	Length (T)	Weight	Part no.
	Keyboard tray magnetic with fold-up function max. load capacity: 5 kg / 11 lbs	30S: 300 x 210 mm / 11.8 x 8.3" 40S: 400 x 150 mm / 15.8 x 5.9" 50S: 500 x 200 mm / 19.7 x 7.9" 58S: 580 x 200 mm / 22.8 x 7.9" 65S: 650 x 200 mm / 25.6 x 7.9"	2.4 kg / 5.3 lbs 2.5 kg / 5.5 lbs 2.9 kg / 6.4 lbs 3.1 kg / 6.8 lbs 3.3 kg / 7.3 lbs	Z-EF-Y.CD_T
	Keyboard tray with fold-up function and left/ right retractable mouse tray max. load capacity: 5 kg / 11 lbs	RC: 480 x 220 mm / 18.9 x 8.7"	3.5 kg / 7.7 lbs	Z-EF-Y.CD_T
	Keyboard tray magnetic retractable and with fold-up function max. load capacity: 5 kg / 11 lbs	50S: 500 x 200 mm / 19.7 x 7.9" 58S: 580 x 200 mm / 22.8 x 7.9"	3.1 kg / 6.8 lbs 3.3 kg / 7.3 lbs	Z-ER-Y.CD_T

Colours to choose

Decorative parts (C)

- gr = RAL 7024 (graphite grey)
- bl = RAL 5013 (cobalt blue)

Aluminium parts (D)

- 1 = RAL 9016 (traffic white)
- 2 = RAL 9002 (grey white)

Fixings Y

details page 27



5

Horizontal rail clamp



3

Vertical rail clamp



4S

Adapter for vertical wall channel



1V

Universal pole clamp

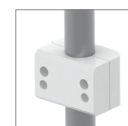

1

1B

1F





1C

Fixed pole clamp

Fixings Y

for keyboard trays



Illustration	Description	Notes	Weight	Part no.
	Horizontal rail clamp	To mount to horizontal European rail 10 x 25, 8 x 35, 10 x 30 mm	0.4 kg / 0.9 lbs	5
	Vertical rail clamp	To mount to vertical European rail 10 x 25 mm	0.5 kg / 1.1 lbs	3
	Adapter for vertical wall channel	To mount to CIM wall channel (compatible with GCX channel)	0.6 kg / 1.3 lbs	4S
	Universal pole clamp	V-block to mount to poles ø 23 - 40 mm / ø 0.9 - 1.6"	0.6 kg / 1.3 lbs	1V
	Fixed pole clamp	To mount to pole ø 25 mm / ø 1" To mount to pole ø 30 mm / ø 1.2" To mount to pole ø 35 mm / ø 1.4" To mount to pole ø 38 mm / ø 1.5"	0.3 kg / 0.7 lbs 0.4 kg / 0.9 lbs 0.4 kg / 0.9 lbs 0.4 kg / 0.9 lbs	1 1B 1F 1C

Handle



Illustration	Description	Notes	Weight	Part no.
	Dual handle with VESA fixing	For monitors with a maximum width of 430 mm / 16.9"	1.5 kg / 3.3 lbs	Z-HDG.1_43
		570 mm / 22.4"	1.9 kg / 4.2 lbs	Z-HDG.1_57

Example of use Z-HDG.1



	Handle for carts	Colours to choose (C): RAL 5013 cobalt blue (bl) or RAL 7024 graphite grey (gr) or RAL 9016 traffic white (w)	0.8 kg/ 1.8 lbs	Z-HD-4.C1
---	-------------------------	--	-----------------	-----------

Example of use Z-HD-4.gr1

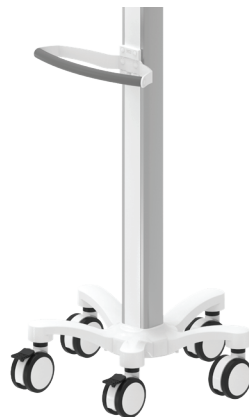

Handle

Illustration	Description	Notes	Weight	Part no.
	Handle for monitor mount VESA	Colours to choose (C): RAL 7024 graphite grey (gr) or RAL 5013 cobalt blue (bl) Colour of the aluminium parts (D): RAL 9016 traffic white (1) or RAL 9002 greywhite (2)	1 kg / 2.2 lbs	Z-HD-G.CD

Example of use Z-HD-G.gr1



	Handle for 5" plunge plate, Mindray and Philips	Colours to choose (C): RAL 7024 graphite grey (gr) or RAL 5013 cobalt blue (bl)	0.5 kg / 1.1 lbs	Z-HDR-HZ.C
---	--	---	------------------	------------

Example of use Z-HDR-HZ



5" Plunge Plate



Philips Table Top Mount



Mindray Mounting Adapter

Down post



Illustration	Description	Notes	Weight	Part no.
	Down post, rotatable	For non-height adjustable arms:		
		L 150 mm / 5.9", max. load 12 kg / 26.5 lbs	0.2 kg / 0.4 lbs	Z-DPR-70.CD_150
		L 300 mm / 11.8", max. load 10 kg / 22 lbs	0.3 kg / 0.7 lbs	Z-DPR-70.CD_300
		For height adjustable arms:		
		L 150 mm / 5.9", max. load 12 kg / 26.5 lbs	0.2 kg / 0.4 lbs	Z-DPR-71.CD_150
		L 300 mm / 11.8", max. load 10 kg / 22 lbs	0.3 kg / 0.7 lbs	Z-DPR-71.CD_300

Colours to choose

Decorative parts (C)

gr = RAL 7024 (graphite grey)
bl = RAL 5013 (cobalt blue)

Aluminium parts (D)

1 = RAL 9016 (traffic white)
2 = RAL 9002 (grey white)

Miscellaneous

Illustration	Description	Notes	Weight	Part no.	
	Bottle holder	Incl. adapter to mount to CIM wall channel (compatible with GCX channel) Please order CIM wall channel separately Max. bottle diameter: 140 mm / 5.5" Maximum weight: 25 kg / 55.1 lbs (6-fold safety)	1.1 kg / 2.4 lbs	Z-GFH-4.1	
	Mounting solution for barcode scanner	For Z-bracket right hand side* For IT lift right hand side* *) When the holder is ordered together with the support arm For Z-bracket right hand side	0.4 kg / 0.9 lbs 0.4 kg / 0.9 lbs	0-BCS-Mr.1 0-BCS-IT Z-BCS-Mr.CD	
	Mounting solution for barcode scanner	Fixing details page 32	0.2 kg / 0.4 lbs	Z-BCS-Y.1	
	Mounting solution for barcode scanner for CIM keyboard tray	Can be mounted left and right side of keyboard trays with non-retractable mouse trays	0.3 kg / 0.7 lbs	Z-BCS-TAB.1	

Fixings Y

for holder barcode scanner

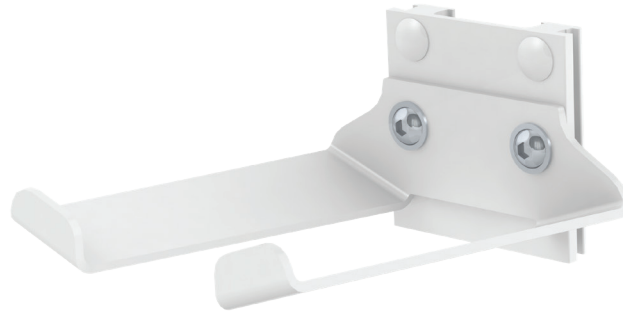





Illustration	Description	Notes	Weight	Part no.
	Horizontal rail clamp	To mount to horizontal rail 10 x 25, 8 x 35, 10 x 30, 10 x 50 mm	0.2 kg / 0.4 lbs	6H
	Vertical rail clamp	To mount to vertical rail 10 x 25, 8 x 35, 10 x 30, 10 x 50 mm	0.2 kg / 0.4 lbs	6V
	Adapter for vertical wall channel	To mount to vertical CIM wall channel (compatible with GCX channel)	0.1 kg / 0.2 lbs	4Z
	Fixed pole clamp	To mount to pole \varnothing 25 mm / \varnothing 1"	0.6 kg / 1.3 lbs	1



CIM med GmbH

Euro-Industriepark
Margot-Kalinke-Str. 9
80939 Munich / Germany

T +49 89. 978 94 08-0

CIM med Inc.

University Executive Park
301 McCullough Drive, Suite 400
Charlotte NC, 28262 / USA

T +1 704 221 0721

info@cim-med.com
www.cim-med.com

